

SMS 由任 SMS Union

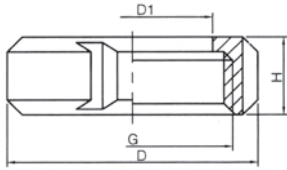

W2101



圆螺母 (推荐系列)
Round nut (recommended series)

Size	D	D1	G	H
ø25	50	32	Rd40×1/6	20
ø32	59	40	Rd48×1/6	20
ø38	71.5	51	Rd60×1/6	21
ø51	81	60.5	Rd70×1/6	22
ø63	97	75	Rd85×1/6	24
ø76	110	86	Rd98×1/6	24
ø89	125	100	Rd105×1/6	27
ø102 min	138	113	Rd125×1/4	27
ø102 max	146	120.5	Rd132×1/6	27

W2102

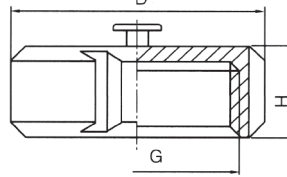

盲螺母 (推荐系列)
Blind nut (recommended series)

Size	D	G	H
ø25	50	Rd40×1/6	20
ø32	59	Rd48×1/6	20
ø38	71.5	Rd60×1/6	21
ø51	81	Rd70×1/6	22
ø63	97	Rd85×1/6	24
ø76	110	Rd98×1/6	24
ø89	125	Rd105×1/6	27
ø102 min	138	Rd125×1/4	27
ø102 max	146	Rd132×1/6	27

W2103



垫圈
Gasket

Size	D1	H
ø25	31.8	5.5
ø32	40	5.5
ø38	48	5.5
ø51	61	5.5
ø63	73	5.5
ø76	86	6
ø89	98	6
ø102	114	6

W2104

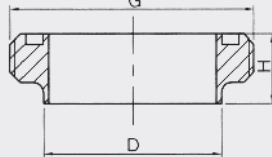

螺纹接头 (推荐系列)
Male (recommended series)

Size	D	G	H
ø25	25.4	Rd40×1/6	20
ø32	31.8	Rd48×1/6	21
ø38	38.1	Rd60×1/6	19
ø51	50.8	Rd70×1/6	20
ø63	63.5	Rd85×1/6	24
ø76	76.2	Rd98×1/6	22
ø89	89	Rd105×1/6	25
ø102 min	101.6	Rd125×1/4	29
ø102 max	101.6	Rd132×1/6	29

W2105

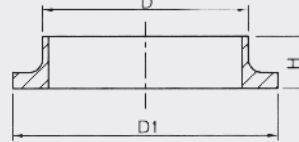

平接头 (圆弧型)
Circular liner

Size	D	D1	H
ø25	25.4	35.5	12
ø32	31.8	43.5	12
ø38	38.1	55.5	13
ø51	50.8	65.5	13
ø63	63.5	80	15
ø76	76.2	90	14
ø89	89	105	15
ø102 min	101.6	118	15
ø102 max	101.6	127.5	15

W2106

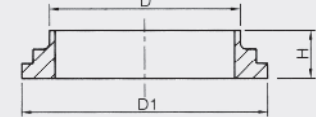

平接头 (台阶型)
Stepped liner

Size	D	D1	H
ø25	25.4	35.5	12
ø32	31.8	43.5	12
ø38	38.1	55.5	13
ø51	50.8	65.5	13
ø63	63.5	80.5	15
ø76	76.2	90	14
ø89	89	105	15
ø102 min	101.6	118	15
ø102 max	101.6	127.5	15

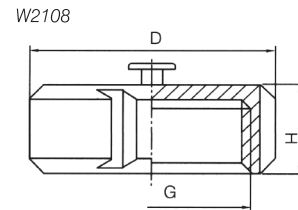
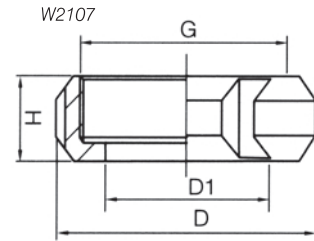

长型圆螺母 / 盲螺母 (可带链条)
Long round nut / Blind nut
(available with chain)

Size	D	G	H
ø25	51	Rd40×1/6	20
ø38	74	Rd60×1/6	25
ø51	84	Rd70×1/6	26
ø63	100	Rd85×1/6	30
ø76	114	Rd98×1/6	32
ø102 min	140	Rd125×1/4	32
ø102 max	154	Rd132×1/6	45

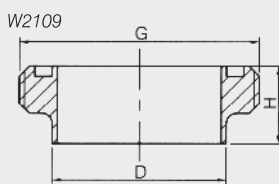

长型螺纹接头
Long male

Size	D	G	H
ø25	25.4	Rd40×1/6	19
ø38	38.1	Rd60×1/6	23
ø51	50.8	Rd70×1/6	23
ø63	63.5	Rd85×1/6	27
ø76	76.2	Rd98×1/6	27
ø102 min	101.6	Rd125×1/4	30
ø102 max	101.6	Rd132×1/6	30

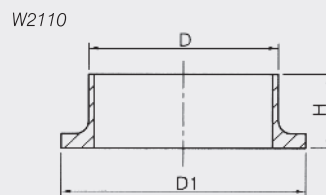

长型平接头 (圆弧型)
Long circular liner

Size	D	D1	H
ø25	25.4	35.5	15
ø38	38.1	55.5	20
ø51	50.8	65.5	20
ø63	63.5	80	21
ø76	76.2	93	21
ø102 min	101.6	118	21
ø102 max	101.6	127.5	21

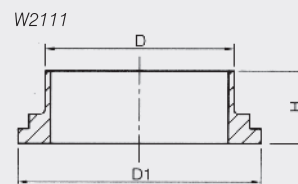

长型平接头 (台阶型)
Long stepped liner

Size	D	D1	H
ø25	25.4	35.5	15
ø38	38.1	55.5	20
ø51	50.8	65.5	20
ø63	63.5	80.5	21
ø76	76.2	93.5	21
ø102 min	101.6	118	21
ø102 max	101.6	127.5	21

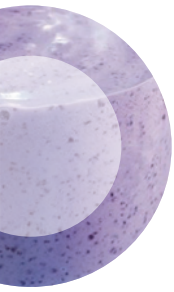

DIN 由任 DIN Union



DIN 由任垫圈
DIN Union gasket

Size	D1	H
DN10	20	4
DN15	26	5
DN20	33	5
DN25	40	5
DN32	46	5
DN40	52	5
DN50	64	5
DN65	81	5
DN80	95	5
DN100	114	5
DN125	142	6
DN150	167	6

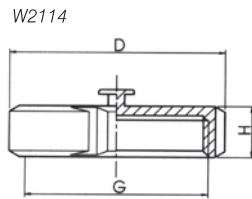
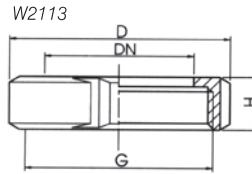

DIN 圆螺母
DIN Round nut

Size	DN	D	G	H
DN10	19	38	Rd28×1/8	18
DN15	25	44	Rd34×1/8	18
DN20	31	54	Rd44×1/6	20
DN25	36	62	Rd52×1/6	21
DN32	42	70	Rd58×1/6	21
DN40	49	77	Rd65×1/6	21
DN50	62	91	Rd78×1/6	22
DN65	80	112	Rd95×1/6	25
DN80	94	125	Rd110×1/4	27
DN100	115	147	Rd130×1/4	29
DN125	138	178	Rd160×1/4	32
DN150	164	208	Rd119×1/4	34

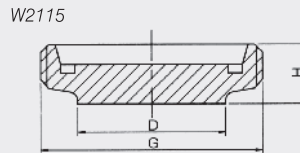

DIN 盲螺纹接头
DIN Blind male

Size	D	G	H
DN15	18	Rd34×1/8	17
DN20	22	Rd44×1/6	19
DN25	28	Rd52×1/6	20
DN32	34	Rd58×1/6	20
DN40	40	Rd65×1/6	20
DN50	52	Rd78×1/6	21
DN65	70	Rd95×1/6	23
DN80	85	Rd110×1/4	25
DN100	104	Rd130×1/4	28
DN125	129	Rd160×1/4	30
DN150	154	Rd190×1/4	32

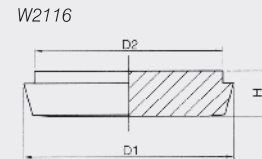

DIN 盲平接头
DIN Blind ferrule

Size	D	D1	H
DN15	28	24	9
DN20	36	30	11
DN25	44	35	13
DN32	50	41	13
DN40	56	48	13
DN50	68	61	15
DN65	86	79	16
DN80	100	93	16
DN100	121	114	20
DN125	150	137	22
DN150	176	163	24

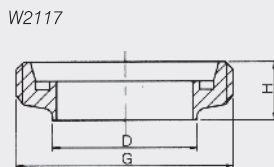

DIN11850 系列 0&2 短螺纹接头
DIN11850 series 0&2 Short male

Size	D	G	H
DN15	18/19	Rd34×1/8	17
DN20	22/23	Rd44×1/6	19
DN25	28/29	Rd52×1/6	22
DN32	34/35	Rd58×1/6	23
DN40	40/41	Rd65×1/6	21
DN50	52/53	Rd78×1/6	22
DN65	70	Rd95×1/6	25
DN80	85	Rd110×1/4	25
DN100	104	Rd130×1/4	30
DN125	129	Rd160×1/4	33
DN150	154	Rd190×1/4	35

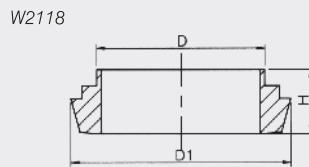

DIN11850 系列 0&2 短型台阶型平接头
DIN11850 series 0&2 Short Stepped liner

Size	D	D1	H
DN15	18/19	28	13
DN20	22/23	36	15
DN25	28/29	44	17
DN32	34/35	50	17
DN40	40/41	56	19
DN50	52/53	68	20
DN65	70	86	20
DN80	85	100	23
DN100	104	121	26
DN125	129	150	33
DN150	154	176	34

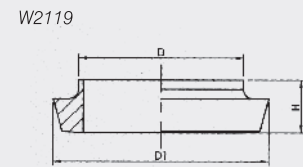

DIN11850 系列 0&2 短型平接头
DIN11850 series 0&2 Short Liner

Size	D	D1	H
DN10	12/13	22	13
DN15	18/19	28	13
DN20	22/23	36	13
DN25	28/29	44	15.5
DN32	34/35	50	16
DN40	40/41	56	16
DN50	52/53	68	17
DN65	70	86	18
DN80	85	100	17
DN100	104	121	21
DN125	129	150	25
DN150	154	176	30

W2120

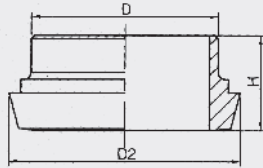

DIN11851 长厚型平接头
DIN11851 Long liner

Size	D	D1	H
DN10	15	22	17
DN15	21	28	17
DN20	25	36	18
DN25	31	44	22
DN32	37	50	25
DN40	43	56	26
DN50	55	68	28
DN65	72	86	32
DN80	87	100	37
DN100	106	121	44
DN125	132	150	34
DN150	157	176	37

W2121

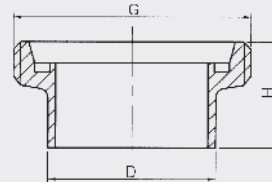

DIN11851 长厚型螺纹接头
DIN11851 Long male

Size	D	G	H
DN10	15	Rd28×1/8	21
DN15	21	Rd34×1/8	21
DN20	25	Rd44×1/6	24
DN25	31	Rd52×1/6	29
DN32	37	Rd58×1/6	32
DN40	43	Rd65×1/6	33
DN50	55	Rd78×1/6	35
DN65	72	Rd95×1/6	40
DN80	87	Rd110×1/4	45
DN100	106	Rd130×1/4	54
DN125	132	Rd160×1/4	46
DN150	157	Rd190×1/4	50

W2122

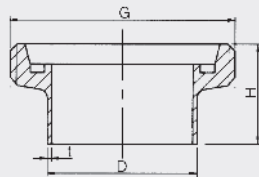

DIN11850 系列 O&2 长型螺纹接头
DIN11850 Series O&2 Long male

Size	D		t	G	H
	0	2			
DN10	12	13	1.5	Rd28×1/8	21
DN15	18	19	1.5	Rd34×1/8	21
DN20	22	23	1.5	Rd44×1/6	24
DN25	28	29	1.5	Rd52×1/6	29
DN32	34	35	1.5	Rd58×1/6	32
DN40	40	41	1.5	Rd65×1/6	33
DN50	52	53	1.5	Rd78×1/6	35
DN65	-	70	2	Rd95×1/6	40
DN80	-	85	2	Rd110×1/4	45
DN100	-	104	2	Rd130×1/4	54
DN125	-	129	2	Rd160×1/4	46
DN150	-	154	2	Rd190×1/4	50

W2123

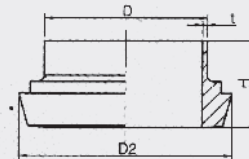

DIN11850 系列 O&2 长型平接头
DIN11850 Series O&2 Long liner

Size	D		t	D2	H
	0	2			
DN10	12	13	1.5	22	17
DN15	18	19	1.5	28	17
DN20	22	23	1.5	36	18
DN25	28	29	1.5	44	22
DN32	34	35	1.5	50	25
DN40	40	41	1.5	56	26
DN50	52	53	1.5	68	28
DN65	-	70	2	86	32
DN80	-	85	2	100	37
DN100	-	104	2	121	44
DN125	-	129	2	150	34
DN150	-	154	2	176	37



ISO/IDF 由任 ISO/IDF Union



W2124

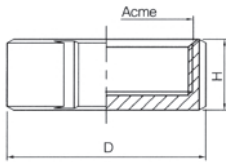

盲螺母
Blind nut

Size	D	TACME	H
1"	48	38.3×8	30
1 1/2"	62	51.8×8	30
2"	76	65.3×8	30
2 1/2"	90	78.8×8	30
3"	103	92.3×8	30
4"(ISO)	133	119.4×8	35
4"(IDF)	142	127.2×6	35

W2125

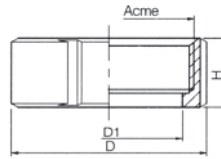

圆螺母
Round nut

Size	D	D1	TACME	H
1"	48	30.5	38.3×8	30
1 1/2"	62	43.5	51.8×8	30
2"	76	57	65.3×8	30
2 1/2"	90	70.7	78.8×8	30
3"	103	83.3	92.3×8	30
4"(ISO)	133	110	119.4×8	35
4"(IDF)	142	112	127.2×6	35

W2126

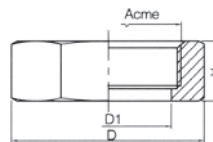

六角螺母
Hexagon nut

Size	D1	TACME	D	H
1"	30.5	38.3×8	53.1	30
1 1/2"	45	51.8×8	69.3	30
2"	57	65.3×8	86.6	30
2 1/2"	70.7	78.8×8	103.9	30
3"	83.3	92.3×8	121.2	30
4"(ISO)	110	119.4×8	155.9	35
4"(IDF)	112	127.2×6	165.1	35

W2127

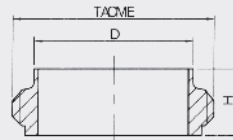

螺纹接头
Male

Size	D		TACME	H
	ISO	IDF		
1"	25.6	25.4	37.13×8	21.5
1 1/2"	38.6	38.1	50.65×8	21.5
2"	51.6	50.8	64.16×8	21.5
2 1/2"	64.1	63.5	77.7×8	21.5
3"	76.7	76.2	91.2×8	21.5
4"(ISO)	102.5	-	118.4×8	21.5
4"(IDF)	-	101.6	125.9×6	30

W2128

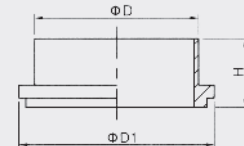

平接头
Liner

Size	D			H
	ISO	IDF	D1	
1"	25.6	25.4	33.8	21.5
1 1/2"	38.6	38.1	47	21.5
2"	51.6	50.8	60.5	21.5
2 1/2"	64.1	63.5	74	21.5
3"	76.7	76.2	87.5	21.5
4"(ISO)	102.5	-	114.4	21.5
4"(IDF)	-	101.6	120.6	30



W2129

IDF 膨胀型螺纹接头
IDF Expanded male

Size	D	TACME	H
1"	29.2	37.13×8	16.5
1 1/2"	42.7	50.65×8	19.5
2"	56.2	64.16×8	19.5
2 1/2"	69.9	77.7×8	25
3"	82.6	91.2×8	30
4"	111.1	125.9×6	35

W2130

IDF 膨胀型平接头
IDF Expanded liner

Size	D	D1	H
1"	25.5	33.8	20
1 1/2"	38.2	47	20
2"	50.9	60.5	25
2 1/2"	63.6	74	30
3"	76.3	84.5	30
4"	101.7	120.6	30

W2133



垫圈
Union gasket

Size	D1	H
1"	32.5	7
1 1/2"	46	7
2"	59.5	7
2 1/2"	73	7
3"	86.5	7
4"(ISO)	113.1	7
4"(IDF)	119	9.6

W2131

盲平接头
Blind ferrule

Size	D	D1	H
1"	29.5	33.8	11
1 1/2"	42.5	47	11
2"	56	60.5	11
2 1/2"	70	74	11
3"	82.3	87.5	11
4"(ISO)	109	114.1	11
4"(IDF)	111	120.6	11

W2132

盲螺纹接头
Blind male

Size	D		TACME	H
	ISO	IDF		
1"	25.6	25.4	37.13×8	21.5
1 1/2"	38.6	38.1	50.65×8	21.5
2"	51.6	50.8	64.16×8	21.5
2 1/2"	64.1	63.5	77.7×8	21.5
3"	76.7	76.2	91.2×8	21.5
4"(ISO)	102.5	-	118.4×8	21.5
4"(IDF)	-	101.6	125.9×8	30



RJT 由任 RJT Union

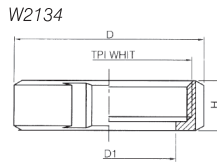

圆螺母 Round nut

Size	D	D1	TPI/WHIT	H
1"	33.3	56	45.7×8	22
1 1/2"	46	69	58.4×8	22
2"	58.7	83	72.7×6	22
2 1/2"	71.4	97	85.4×6	22
3"	84.1	110	98.1×6	22
4"	109.7	136	123.5×6	22
6"	163	197	174.3×6	23.5

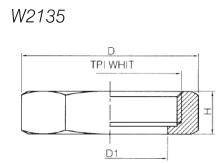

六角螺母 Hexagon nut

Size	D	D1	TPI/WHIT	H
1"	33.3	58.66	45.7×8	22
1 1/2"	46	73.9	58.4×8	22
2"	58.7	90.07	72.7×6	22
2 1/2"	71.4	105.08	85.4×6	22
3"	84.1	120.09	98.1×6	22
4"	109.7	150.11	123.5×6	22
6"	163	203.5	174.3×6	24

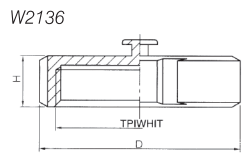

盲螺母 Blind nut

Size	D	TPI/WHIT	H
1"	56	45.7×8	22
1 1/2"	69	58.4×8	22
2"	83	72.7×6	22
2 1/2"	97	85.4×6	22
3"	110	98.1×6	22
4"	136	123.5×6	22
6"	197	174.3×6	23.5

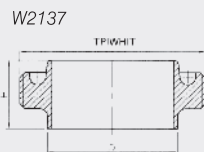

螺纹接头 (长型系列) Long male

Size	D	TPI/WHIT	H
1"	25.65	45.7×8	27
1 1/2"	38.35	58.4×8	27
2"	51.05	72.7×6	27
2 1/2"	63.75	85.4×6	27
3"	76.45	98.1×6	27
4"	101.85	123.5×6	27
6"	152.4	174.3×6	24

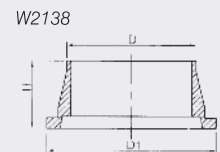

平接头 (长型系列) RJT-AS Long liner(RJT-AS)

Size	D	D1	H
1"	25.65	41.3	27
1 1/2"	38.35	54	27
2"	51.05	66.7	27
2 1/2"	63.75	79.4	27
3"	76.45	92.1	27
4"	101.85	117.5	27

W2139



螺纹接头 (短型系列)
Short male

Size	D	TPIWHT	H
1"	25.65	45.7×8	21.5
1 1/2"	38.35	58.4×8	21.5
2"	51.05	72.7×6	21.5
2 1/2"	63.75	85.4×6	21.5
3"	76.45	98.1×6	21.5
4"	101.85	123.5×6	21.5

W2140

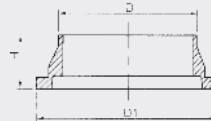

平接头 (短型系列) RJT-AS
Short liner(RJT-AS)

Size	D	D1	H
1"	25.65	41.3	19.5
1 1/2"	38.35	54	19.5
2"	51.05	66.7	19.5
2 1/2"	63.75	79.4	19.5
3"	76.45	92.1	19.5
4"	101.85	117.5	19.5
6"	152.4	169.1	23.5

W2141



平接头 (短型系列) RJT-BS
Short liner(RJT-BS)

Size	D	D1	H
1"	25.65	41.3	10/12.7
1 1/2"	38.35	54	10/12.7
2"	51.05	66.7	10/12.7
2 1/2"	63.75	79.4	10/12.7
3"	76.45	92.1	10/12.7
4"	101.85	117.5	12.7/25.4

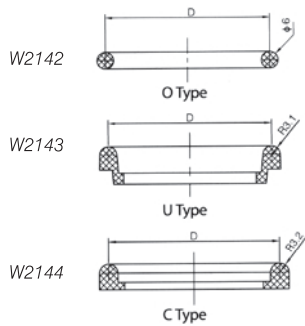

○型密封圈
O-ring

Size	D
1"	33.3
1 1/2"	46
2"	58.7
2 1/2"	71.4
3"	84.1
4"	109.5
6"	162.6

W2145

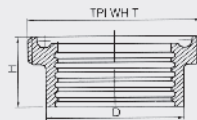

膨胀螺纹接头
Expanded Male

Size	D	TPIWHT	H
1"	32.5	45.7×8	20
1 1/2"	45.2	58.4×8	24
2"	57.9	72.7×6	28
2 1/2"	70.6	85.4×6	32
3"	83.3	98.1×6	32
4"	108.7	123.8×6	32

W2146

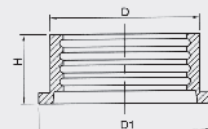

膨胀式平接头
Expanded liner

Size	D	D1	H
1"	32.5	41.3	20
1 1/2"	45.2	54	24
2"	57.9	66.7	28
2 1/2"	70.6	79.4	32
3"	83.3	92.1	32
4"	108.7	117.5	32